

**KLEWE**  
SISTEMASOLARE

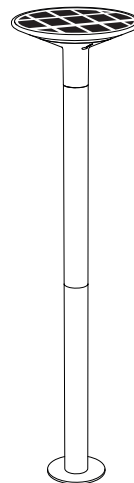

**KEOPE GROUND**



MADE IN CHINA

DESIGNED IN ITALY BY FRANCO PAGLIARINI  
[WWW.KLEWESOLAR.EU](http://WWW.KLEWESOLAR.EU)

VERSION 1.0 

1.

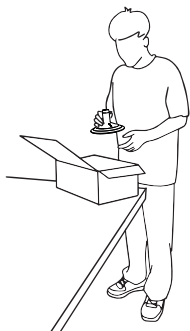

2.

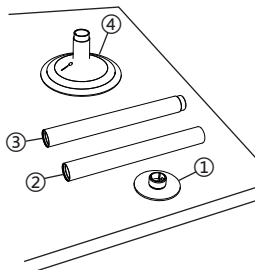

3.

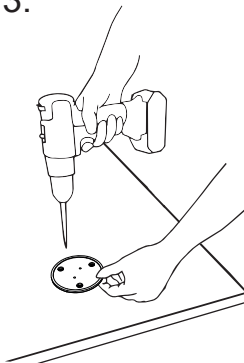

4.



5.

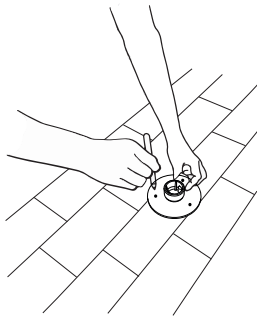

6.

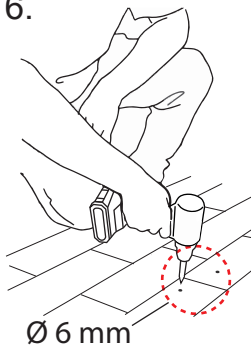

7.

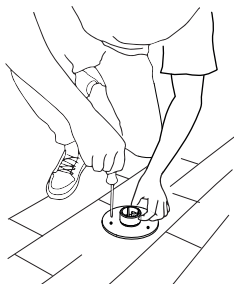

8.

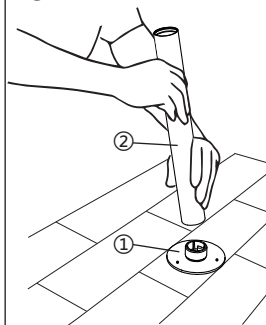

9.

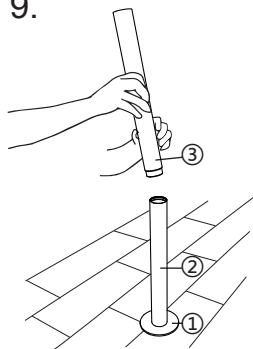

10.

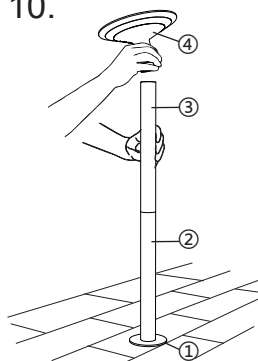

11.

> 3s

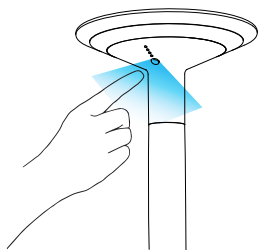

12.

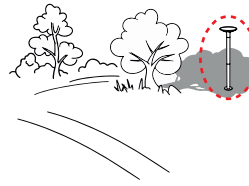
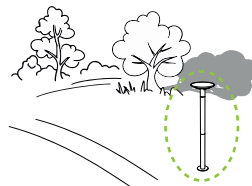
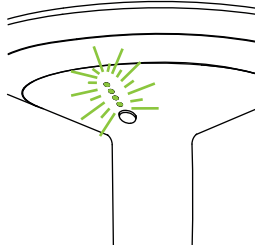

< 50LUX

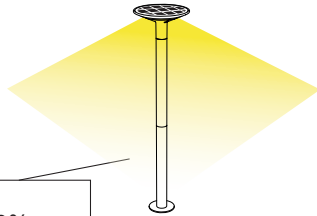

1h	30%
2-4h	100%
5h----	20%
*	20%

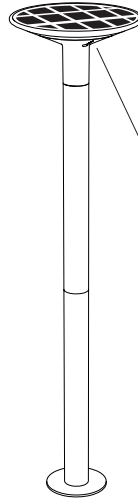

	100% ↔ 75%	
	75% ↔ 50%	
	50% ↔ 25%	
	25% ↔ 10%	
	10% ↔ 2%	
	< 2%	
	0%	

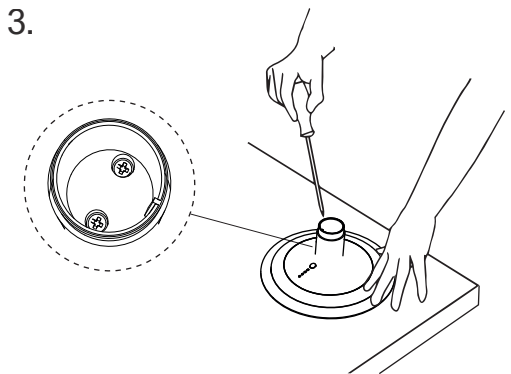
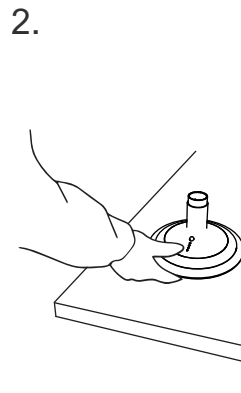
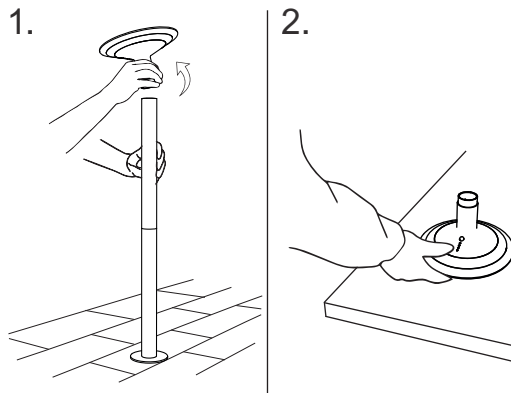
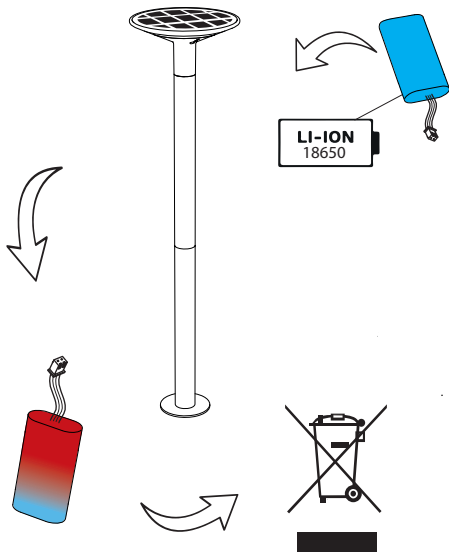

4.

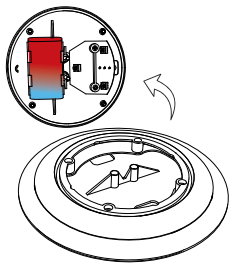

5.

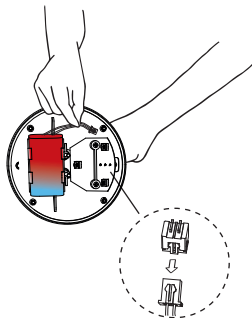

6.

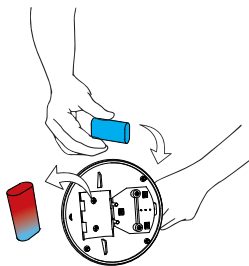

7.

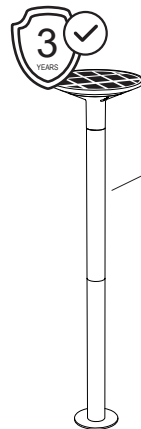
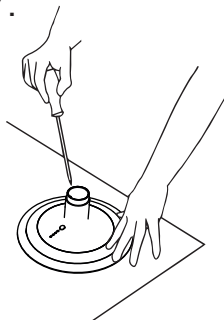

IP65



10-12h



23-25h

Watt

3



4400 mAh



3.5W 7V



3000K

CRI

>80

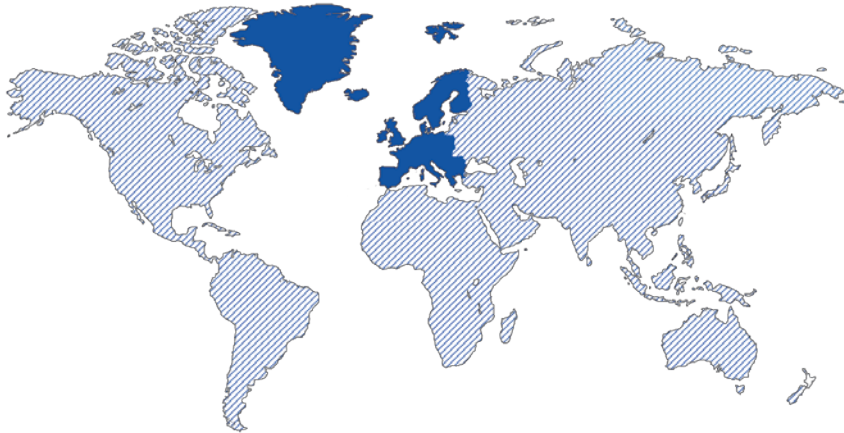

 **Europe:**



[www.klewesolar.eu](http://www.klewesolar.eu)

 **Worldwide:**



[www.klewesolar.com](http://www.klewesolar.com)



[info@eddsrl.eu](mailto:info@eddsrl.eu)



[info@klewesolar.com](mailto:info@klewesolar.com)